

# St. Peter's Dynevor Windmill

**A Graphic Recreation of an  
Early Nineteenth Century  
Industrial Landmark**

David Butterfield  
2015

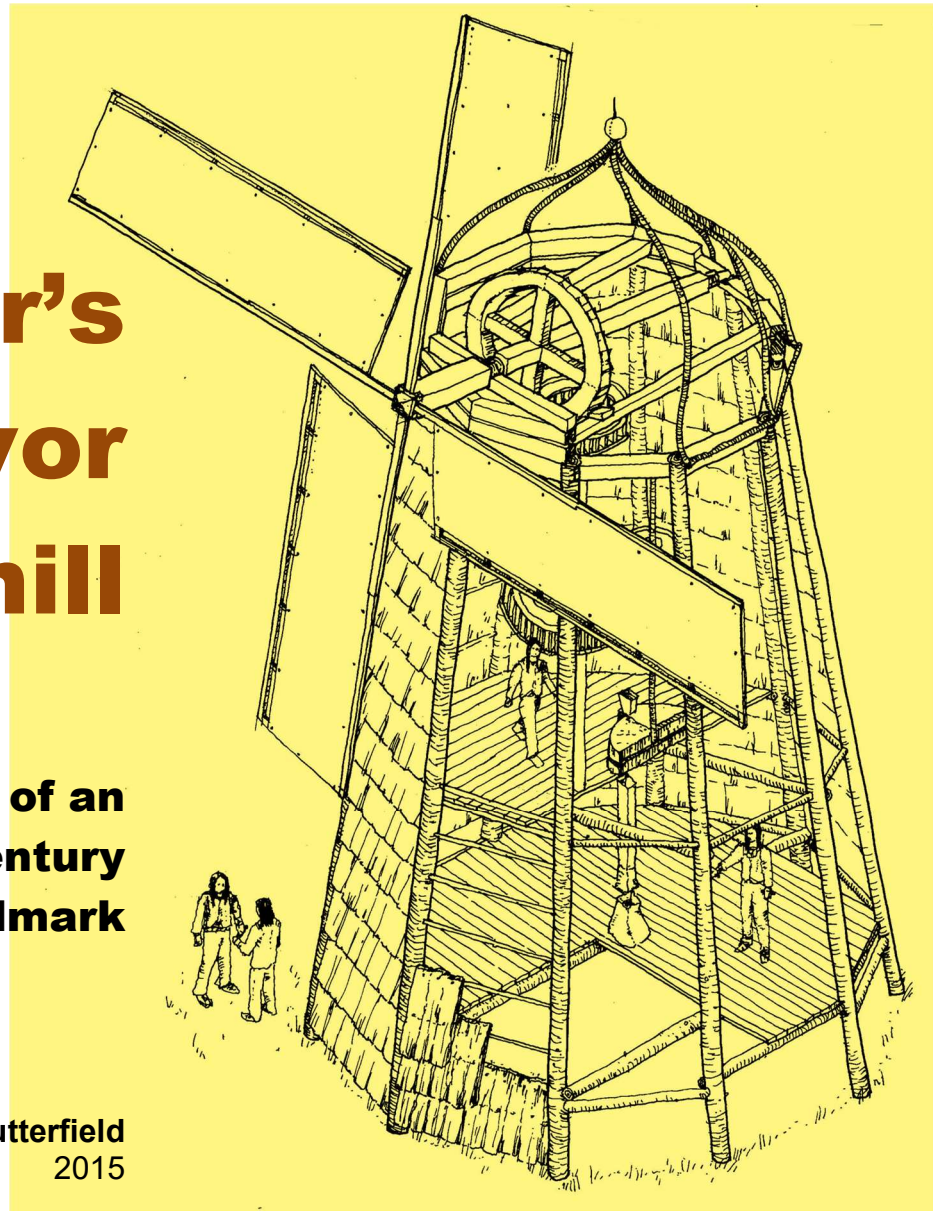

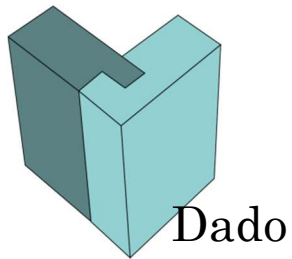

**St. Peter's Dynevor Windmill: A Graphic Recreation of a Mid-Nineteenth Century Manitoba Landmark** has been developed by Dado Projects, a Manitoba heritage research initiative of Maureen Devanik and David Butterfield. These projects are supported by Heritage Manitoba, an informal coalition of municipal heritage associations dedicated to the appreciation and preservation of Manitoba's history. The project is part of a series focusing on Manitoba's early industrial development, especially in small-town or rural situations. Other projects in the series include:

- The Former Manitou Gas Company Plant
- The James White Sash and Door Factory of Carberry
- The Leary Brick Factory
- John Gunn's Water Mill

## Introduction

**F**or about 50 years, from 1833 to the mid 1880s, a remarkable community was developed on the banks of the Red River just north of present-day Selkirk. Known at the time as the Indian Settlement, or the Indian Village, this very first Aboriginal agricultural settlement in what would become Manitoba was undertaken by a band of Saulteaux and Cree peoples under the leadership of Chief Peguis.

Over the course of these 50 years these pioneering Aboriginal people broke the land, planted crops and sold their surpluses. They built a school and with help from Anglican missionaries educated their children. They constructed sturdy little log houses, erected first a log and then a fine stone church and put up two windmills to grind their grain for flour production. At the community's height, in the 1850s and 60s, there were approximately 87 families comprising the village, totaling about 500 people.

There is nothing left of the community, more than 130 years later – no houses, no school, certainly no windmills. St. Peter's Dynevor Anglican Church (built beginning in 1852) still stands, but the Aboriginal community is long gone. (There is more on this important aspect of the history of St. Peter's Indian Settlement in the next section.)

Certainly St. Peter's Dynevor Church is an important Manitoba site – in fact it is a designated Provincial Heritage Site. And a great deal has been written about it, as well as all of the other extant churches of the Red River Settlement era – St. Andrew's Anglican, Little Britain Presbyterian, St. Boniface Roman Catholic, St. John's Anglican, St. Clements Anglican. Their various and interesting histories—architecture, construction, designers, builders—are all well documented and have been thoroughly explored and explained.

What is not so well known are buildings like the two windmills at the Indian Settlement. There has been some general research, which is featured in a later section here. But the actual construction and operation of these vital buildings has been little studied.

The two windmills at the Indian Settlement, as well as the 18 others that are presumed to have been built in the early days of the province's history, might have been less architecturally impressive, and un-imbued with the weighty spiritual attributes of the churches, but they were arguably the most important buildings of the Red River Settlement. For it was them (and the nine water mills of the same period) that ensured that the agricultural production of the farming communities—wheat mostly—was ground into flour for bread and other edibles.

This report is mainly an attempt to “recreate” one of the St. Peter's Indian Settlement windmills – to suggest what it looked like, how it operated.

We are fortunate to have a wealth of information as starting points for this work: general histories of windmills and an excellent overview of Manitoba's nineteenth-century mills by Professor Barry Kaye. There are also a number of contemporary images—drawings and photographs—that help in their details to determine certain aspects of early windmill forms and operations.

Imagining the thought that went into the creation of the St. Peter's windmills, then the actual back-breaking work attending its construction, and finally the impressive vitality of its daily operation (at least during the spring and summer months), is to encounter the kind of robust can-do character that continues to inspire respect and admiration. Such an imagining also recalls the ingenuity and sophistication that attended this and other early Manitoba industrial works.

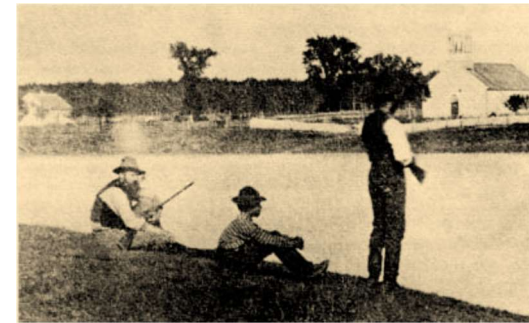

A view from around 1880 looking east from the west bank of the Red River towards St. Peter's Dynevor Anglican Church, suggesting the topography of the Indian Settlement. (Image Courtesy Archives of Manitoba)

## St. Peter's Indian Settlement

**W**hile the main purpose of this project is an exploration and proposed graphic reproduction of an early nineteenth century Manitoba windmill, the choice of the preferred example requires a brief digression to put that mill into its fascinating socio-cultural and physical context.

The site of our windmill was the Red River Settlement's first Aboriginal agricultural colony, north of present-day Selkirk. And the leader of the combined Saulteaux-Cree band that undertook this pioneering work was Chief Peguis, a revered name in Manitoba history.

Chief Peguis was born around 1774 near what is now Sault Ste. Marie, in present-day Ontario. As a young man he led a band of his tribe westward to the Red River area, where they established themselves at Netley Creek, an area within the marshy southern extent of Lake Winnipeg – a superb location for fishing, hunting and trapping. Peguis's people had traded with French fur-traders in the Sault Ste. Marie area, and at their new home formed trade relations with the Hudson's Bay Company (HBC) post at Pembina (in present-day North Dakota).

A significant, and ultimately troubling, change in the Peguis band's lifestyle began between 1812 and 1815, when a group of European settlers from Scotland and Ireland, known as the Selkirk Settlers, arrived in the Red River area. This was a colonization project set up by Thomas Douglas, 5th Earl of Selkirk, who in 1811 had been granted 300,000 square kilometres (120,000 square miles) of land by the Hudson's Bay Company. Selkirk had become interested in the idea of settling the Red River area after reading Alexander Mackenzie's 1801 book on his adventures in what is today the Canadian West.



Chief Peguis later in his life. When he began his work with Reverend Cockran he would have been about 58 years old. (Image Courtesy Archives of Manitoba)

At the time, social upheaval in Scotland due to the introduction of sheep farming and the ensuing Highland and Lowland Clearances had left a number of Scots destitute. Selkirk was interested in giving them a chance at a better life in this proposed colony, which he called Assiniboia.

The early years of the Selkirk colony were extremely challenging—crop failures, disease, and even settler deaths from battles with hostile North West Company fur-traders and their Métis allies—and many of the original settlers left, returning to Great Britain or decamping south or east to more hospitable situations.

For those who remained, it was Peguis and his people who brought the little colony hope and real sustenance. Peguis reached out to them, hunting for them and guiding them to the HBC post at Pembina for shelter when they first arrived. Peguis also developed a personal relationship with Lord Selkirk, with whom the chief signed a treaty in 1817 providing his people with a land settlement, from Sugar Point (near Selkirk) north to Lake Winnipeg.

Shortly after the arrival of the Selkirk Settlers, Roman Catholic and Anglican missionaries began to arrive at Red River. They were tasked with providing local inhabitants—English, Scottish and Métis farmers and traders with Christian services. But an important aspect of their work was the conversion of local Aboriginal peoples to Christianity.

In 1818 a French missionary, Father Joseph Provencher, arrived in the Red River Settlement, in what today is known as St. Boniface, and quickly made his way to visit the Peguis band at their Sugar Point encampment. Two years later a Protestant English missionary named John West arrived, and he too spent time at the Peguis camp. It was the arrival at Red River of Reverend William Cockran, in 1825, that would have truly momentous effects on the Peguis band.



The extent of Lord Selkirk's holding, which comprised parts of present day Manitoba, Saskatchewan and parts of the United States.

William Cockran, about 20 years Chief Peguis's junior, was a major force in the Red River area, providing religious and spiritual instruction at various parishes: first at Upper Church (later St John's), then the Middle Church (later St Paul's) and then at the Lower Church (later St Andrew's). But he was also adamant about providing the practical application of farming and animal husbandry techniques that he realized were essential for all people coming to the area—retired fur traders, Métis, and Aboriginals—that would encourage the kind of sedentary situation that would allow for sustained education and religious instruction.

So it was that in 1832 Cockran persuaded Peguis and a few of his people, who were nearby the Lower Church at St. Andrew's, to settle in a community just north of present-day Selkirk. This site, which came to be called the Indian Settlement or the Indian Village, was the first attempt by local Aboriginal people to develop a farming community.

Some interesting and useful information about the evolution of this settlement is provided via adapted extracts from *Peguis. A Noble Friend*, by Donna Sutherland (self published in 2003, supported by Chief Peguis Heritage Park, Inc.; pages 102-132), slightly abridged here for effect and mostly focused on buildings and context:

By 18 April 1832, most of the snow had thawed and the Red River was clear of ice as far as Netley Creek. Cockran journeyed down (north) the Red in a birch rind canoe with two men towards Sugar Point. From there they continued on to the Saulteaux encampment a little north of the point to discover the most eligible spot to commence the new settlement. They traveled about 10 miles when then came to Peguis's tent. Peguis welcomed them but explained that he would not accompany them further down the river – the waters were too high and the day too cold for traveling. After a short stay, Cockran continued on with the two men. They stopped at the Indians' summer camp and found it to be the only dry piece of ground, consisting of fifteen to twenty acres of arable land.

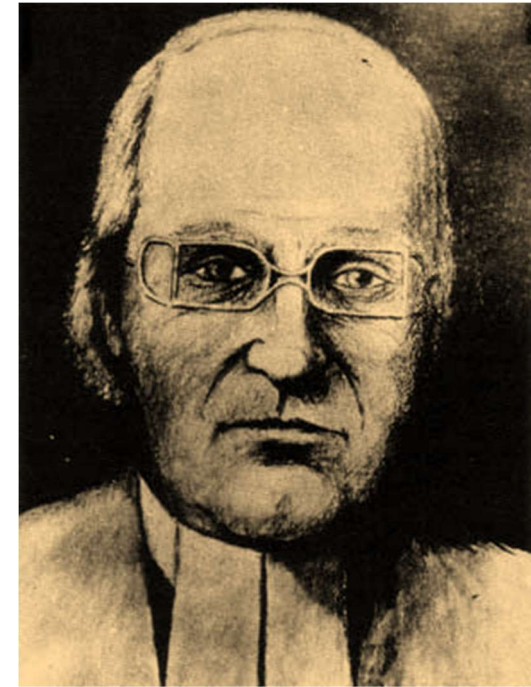

Reverend William Cockran (c.1796-1865) was a driving force in the development of the St. Peter's Indian Settlement. (Image Courtesy Archives of Manitoba)

In the spring of 1832 Peguis, Cockran and six Saulteaux families began breaking the land near Netley Creek. Cockran noted that 70 bushels of potatoes, 10 bushels of barley and three bushels of wheat were planted. Although the initial crops began with promise, the final results were not auspicious. The barley matured to the harvesting stage but the wheat had been damaged by frost and the potatoes were blighted.

By October of 1832 the first house at the settlement, Peguis's naturally, was finished except for mudding the floor. The three Saulteaux men who built the house were known as The Wind, Houlup and The Cannibal. A second house was built for Cockran's local man. This house was about 100 yards farther up (south) the river. A third man, named Red Deer, got a house built with the help of The Cannibal.

By the fall of 1832 nine cottages had been completed for the Netley Creek Saulteaux band, and the small village came to be known as the Indian Farm. All the houses were built from logs with wall seams as well as the chimneys plastered with mud. The roofs were thatched with reeds in addition to being covered with earth [presumably to add weight in windy situations]. The men used a saw to plane the floorboards, doors and beds. The windows were made of parchment from the skins of fish. The little houses were equipped with a trap door in the centre of the floor that lead to the cellar – a place to store their seed and vegetables.

The Netley Creek settlement ultimately proved unsuitable, and in June of 1833 Cockran decided to scout out a location for a new village. He set out on the early morning of 12 June 1833 to survey the river banks for a preferred location, and found a suitable spot on the east bank of the Red River about 12 miles below the Rapids (approximately where the church of St. Peter's Dynevor now stands).



Lord Selkirk's sketch of buildings at the Red River Settlement, done in the summer of 1817 when Selkirk visited the settlement. (Image Courtesy Archives of Manitoba)



Photograph by H.L Hime of Ojibway tipis at Red River, ca. 1858. (Image Courtesy Archives of Manitoba)



Cockran recorded the plan he apparently presented to Peguis: "There the land is of good quality, the large timber has been all destroyed by fire, the bush wood could easily be cut down and the roots dug out with the hoe. The swampy parts could be dried by digging open drains to the creek, to carry off the water. Large fields might be fenced and divided amongst a certain number of families, according to their industry. Each family being obliged to sow, weed, and reap annually the number of acres appointed to their share. . . . The children living with their parents or relatives in the village ought to be assembled every day and taught to read and write. . . . No one ought to be allowed to build in the village who would not send his children to this place of instruction. In the spring the children who are receiving instruction ought to be made to work a certain number of hours upon the farm of their respective parents or relatives to enable them to raise a sufficiency of grain and potatoes to support their families throughout the years. . . . Timber might be rafted down in the summer from the Sugar Point, to build the village and to serve it for fuel. . . . The people living in this village might by and by get some cattle, the cattle by being fed in a band would not be assailable to an attack from the wolves or dogs."

Peguis was positive about the new plan, apparently, and asked Cockran about the disposition of his house at the Netley Creek site; Cockran replied that he would carry it up the river and place it where the new village would be formed, or he might exchange it for a man who would provide the labour to build a new house for Peguis. And so it was agreed.

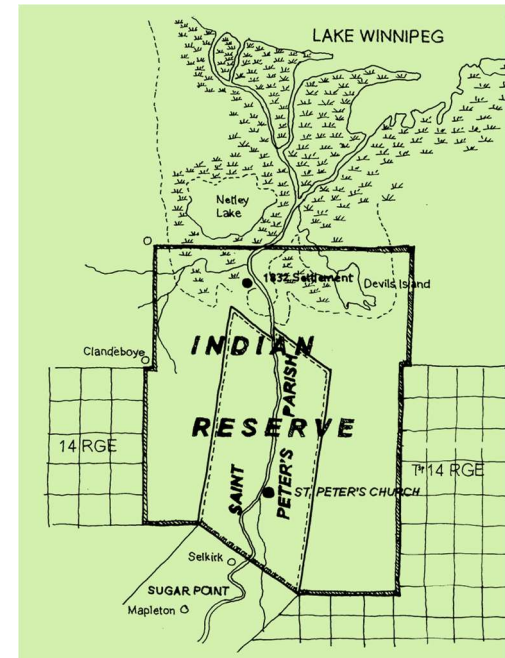

Sketch map showing the immediate vicinity of the Indian Village, here showing the so-called Indian Reserve, Saint Peter's (Anglican) Parish and St. Peter's Church. (Map redrawn from the original courtesy Gary Still, redriverancestry.ca)

Cockran commenced the building program immediately. By August 1833 a house that measured 20 feet in breadth and 40 feet in length had been built. It was used as a school room and store with the upper floor holding seed grain. In addition, a large cellar was dug to store seed potatoes. Reverend Jones (Cockrans' superior) donated £10 for the buildings. Cockran expected six families to settle at the village in the fall of 1833 if enough houses could be built to accommodate them.

By the fall of 1833 the small Saulteaux/Cree village had nine small log houses. They were all about the same size – 24 feet in length by 16 feet in breadth. Each home contained a cellar in the centre of the building to store potatoes.

Building the school room was a challenge, as Cockran and his builders were always deficient in proper tools. While engaged in their project they had only one hand saw, one grooving pick, four chisels, two axes, one cross-cut saw, three augers, a few planes. They persevered however and by November 1833 the school room was nearly ready to admit children.

The first school master was Joseph Cook. He lived at the settlement for the first year by himself until his wife Catherine Sinclair Cook and their children joined him in the summer of 1834. The children were taught to read and write the English language, with an emphasis on learning agricultural trades for the boys and weaving for the girls.

In the spring of 1835 six more log houses were built at the village. That same year saw the school house enlarged to provide more space for Joseph Cook's large family. It is around this time that Cockran provides some useful diary observations about construction practices: "The roof is to be thatched with clay and straw and log walls pegged with wooden pegs and plastered with clay. On the outside above the clay we will put a thin coat of sand and lime, which will turn the rain and prevent the clay being washed off the lags. We also are going to have glass windows."



Sketch of the original early 1800s Grey Nuns' Convent at St. Boniface, a typical log building roofed with thatch. (Image Courtesy Archives of Manitoba)

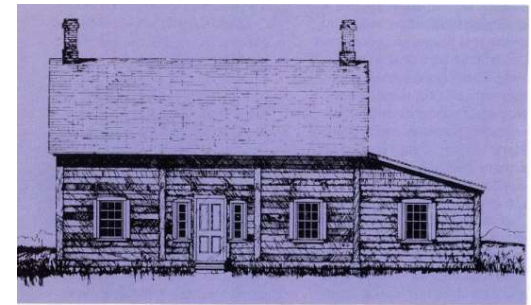

The Pierre Delorme House of 1857 shows the essentials of Red River frame construction – vertical logs infilled with short log members. (Image Courtesy Historic Resources Branch)

Farming continued to increase at the Saulteaux/Cree village, and by 1835 the settlement had 35 acres under cultivation. Cockran decided a grist mill was needed for the people to grind their grain into flour without having to travel to The Rapids to this task. He had trouble finding a carpenter in the Upper Settlement to build the mill, and looked to hire a young Saulteaux man to dig the ground for the 22-foot diameter foundation. It was then to the men of the village that he looked to build the grist mill. Supplies for the construction project were purchased at the Upper Settlement, which meant numerous trips were made up and down the river with supplies.

By the spring of 1836 the Saulteaux/Cree settlement continued to grow and prosper. Peguis was still not persuaded of the merits of Christianity, but he was involved with Cockran in the Christian aspect of the settlement, including the decision to build a church.

The ground upon which the church would sit was chosen in the warm and sunny month of June. The site was on the east bank of the river, north of the present stone church. It was nestled among high trees whose leaves gave shady protection against raging summer sun but prevented any refreshing breezes from reaching the workers, thus creating a sweltering environment to toil in. The church was made of log, hand-sawn and measured 54 feet long by 24 feet wide. The rafters were one foot higher than the log church at The Rapids (St. Andrews), as well as a little longer – a source of some local pride. The building was positioned east and west with the entrance facing west, overlooking the Red. The hand-sawn wood pulpit and reading desk were at the east end on a nine-inch elevated floor. Cockran noted that the new building was equipped with a wood-burning stove, whose heat pipes were placed in a similar pattern to those at the Rapids Church.

By early December 1835 the carpenters were making the pews, while others were whitewashing the walls and painting the ceiling. It was at this time that Cockran built for himself a small house at the settlement, where he could sleep while visiting.

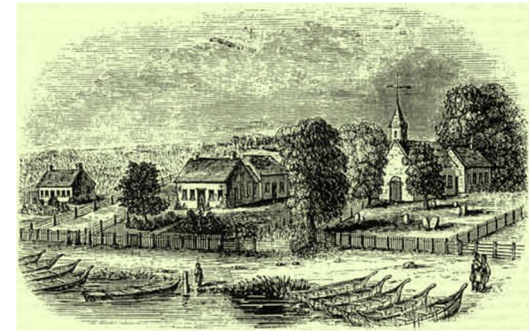

"Indian Settlement at Red River," from G. J. Mountain's journal of 1846. An idealized view of the Indian settlement. (Image Courtesy Archives of Manitoba)



An Ojibway farmer with his team of oxen, likely at St. Peter's. (Image Courtesy Archives of Manitoba)

With the arrival of the new year the little log church was ready for service, and on 4 January 1837, Cockran recorded the exciting event: "Today our new church was opened. Mr Jones performed Divine Service. Though the weather was exceedingly stormy, the wind blowing strong in our faces, and the snow falling so thick as to render the track invisible, yet all the HBC officers who were in the settlement at the time, and a large number of the respectable settlers accompanied us. The pews were full and many sat in the alley." Peguis, along with some members of his family, attended the initial service.

In the summer of 1841 the Indian Settlement was flourishing. The crops were producing large yields with each individual site separated by a wooden fence. By 1843 the settlement was producing a surplus from their crops. This enabled them to send 130 bushels of wheat and 10 bushels of barley to Cumberland House. In that same year the settlement school had a total of 74 children attending – 39 boys and 35 girls.

By 1844 many of the early log houses had deteriorated to the point that they had become uninhabitable. They were demolished and replaced with new ones. Much of the settlement was now growing on the west bank of the Red River across from the church site. The farms consisted of cows, oxen, pigs, sheep and horses. The women of the settlement spun their own wool, as well as made all the clothing for the community. Two years later, in 1846, the people undertook the building of a new grist mill.

The population of the settlement in 1851 was approximately 87 families – totaling about 500 souls. The colony was clearly a success – just 18 years after it had been established. So it was not surprising that at a meeting of the people requested by Cockran on 8 December 1851, that he expressed the idea of building a new church, made of stone and lime: It would be of the same size as the Bishop's Church viz. 76' by 46.'"Cockran was referring to the church of St. John at the Upper Settlement.

Several parishioners promised to provide the 2,800 boards and planks deemed necessary for construction. Others offered their oxen for hauling timber as well as their backs in labour. Some residents, mainly the older ones, offered to supply the workers with fish while they worked.

Construction on the new stone church began in the fall of 1852. Throughout the cool autumn months of October and November the men quarried more than 80 cords of stone from the banks of the Red River (a cord is 12 feet long, 6 feet wide and 3 feet high). Beginning in the early part of January 1853 they began hauling the stone to the building site – a distance of about eight miles. They also hauled 1,680 bushels of lime and an equal quantity of sand.

The first service in the church was held on 19 November 1854. The building was not complete but the old church was in such a bad state that the newly appointed minister, Abraham Cowley, decided the new church would have to be used for the service.

The new church, called St. Peter's Dynevor Anglican, was finally finished in 1857, six years after Cockran had made his original case for the new building. The church was a handsome thing, based on English parish churches. With its impressive limestone walls and elegant wooden spire and steeple, the church is a landmark. A later addition gave the structure a formal chancel, a unique feature among the four pre-1870 Anglican churches that stand along the Red River.

This adapted account from Ms Sutherland continues through another chapter to Chief Peguis's death on September 25, 1864 – he was buried four days later in the cemetery of St. Peter's on a "calm, pretty day," wrote local stonemason Samuel Taylor. Reverend Cockran died one year later on 1 October 1865 in Portage la Prairie. But the essential information for this project—regarding buildings mostly—essentially ends here.

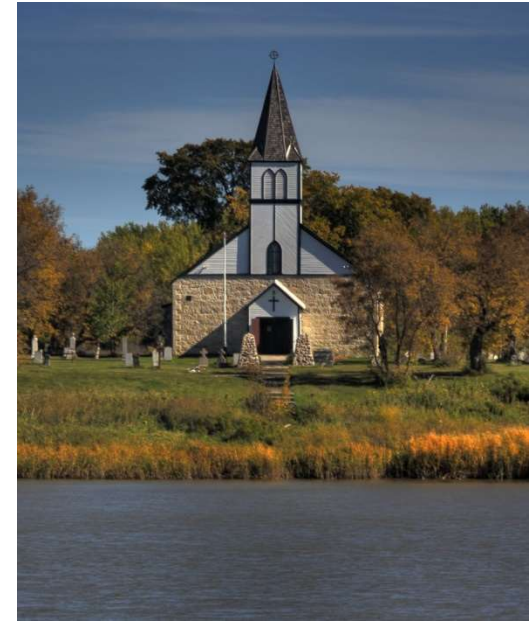

The Parish of St. Peter, Dynevor Old Stone Church.

Some additional context about the demise of the settlement is found in a Historic Resources Branch report:

“In 1857, when [Reverend] Cockran left the Indian settlement and moved to St. Mary’s Church at Portage la Prairie, St. Peter’s was well-established. Within a short time after Cockran’s departure, however, changes began to occur. The Reverend Abraham Cowley, Cockran’s assistant at the Indian settlement, was placed in charge of the church and mission. After Chief Peguis’s death, tensions between the Saulteaux and Cree, and between Christian and non-Christian Aboriginals, grew and caused divisions at the settlement. [More significantly], Canadian settlers who came out to Red River in the 1860s and 1870s in search of rich farmland often bought out the Aboriginal farmers. As the white and Métis presence increased in the area, the native population dispersed. [And] in short time what was once called the “Indian settlement” came to be known as the parish of St. Peter’s.

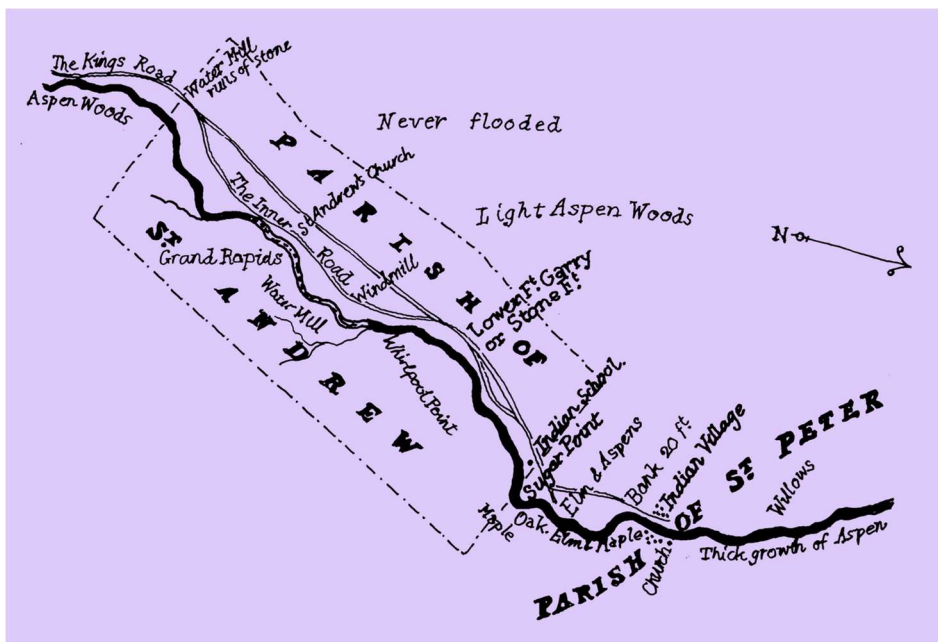

Sketch map showing the immediate vicinity of the Indian Village, with a number of buildings and sites shown, along with roadways and vegetation. The Indian Village and related sites and topography descriptions are situated at the right. (Map redrawn from the original courtesy Gary Still, redriverancestry.ca)

“In 1871 an [Aboriginal] treaty designated St. Peter’s as a reserve, but this did not halt the sale of land or prolong the life of the settlement. By 1875 half of the population of the area were non-treaty and eventually much of the missionary’s painstaking work was undone. Farming became a subsidiary occupation for remaining Aboriginals, who readily re-adapted to hunting and fishing.

“In 1908 St. Peter’s was closed as a reserve. A number of those who still held land in the area sold out and moved north to the newly-opened Peguis Reserve. The old river lots merged into larger farms and the overall population of St. Peter’s parish decreased.”

## Brief History of Windmills

**A** wind wheel designed by the Greek engineer Heron of Alexandria in the first century AD is thought to be the earliest known instance of the use of a wind-driven wheel to power a machine – interestingly for a musical device (shown at right). Indeed, for centuries it was the more obvious activity of rushing water that was exploited for conversion to usable power – for grain-grinding, saw-milling and a multitude of other functions.

The first practical windmills had sails that rotated in a horizontal plane, around a vertical axis (lower right). According to Ahmad Y. al-Hassan, these “panemone” windmills were invented in eastern Persia as recorded by the Persian geographer Estakhri in the ninth century AD. Made of six to 12 sails covered in reed matting or cloth material, these windmills were used to grind grain or draw up water.

In northwestern Europe, the much more familiar horizontal-axis or vertical windmill (so called due to the plane of the movement of its sails) is believed to date from the last quarter of the twelfth century, and was mainly concentrated in the triangle of northern France, eastern England and Flanders. The first English windmill was at Bury St. Edmonds in Suffolk, dating from 1191, followed into the next century by as many as 4,000 in England.

Current evidence suggests that the earliest type of European windmill was the post mill, so named because of the large upright post on which the mill's main structure—the “body” or “buck”—was balanced. By mounting the body this way, the mill was capable of rotating to face the wind direction, an essential requirement for windmills to operate economically in north-western Europe, where wind directions are variable.

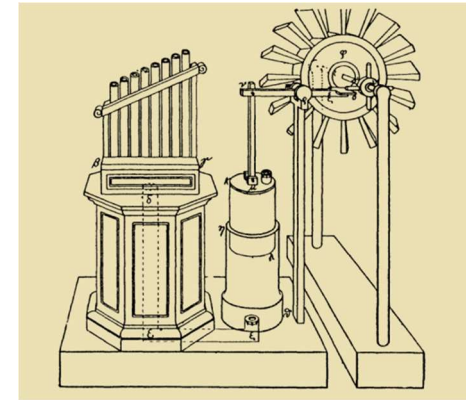

Speculative drawing by W. Schmidt from 1899 showing Heron of Alexandria's wind organ and wind wheel (right side of drawing) (From *Heron von Alexandria Druckwerke und Automaten theater*, Reprint 1971).

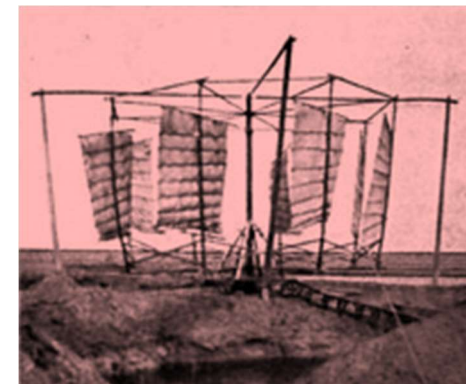

A Chinese example of a horizontal windmill, in which the sails are arranged around vertical members.



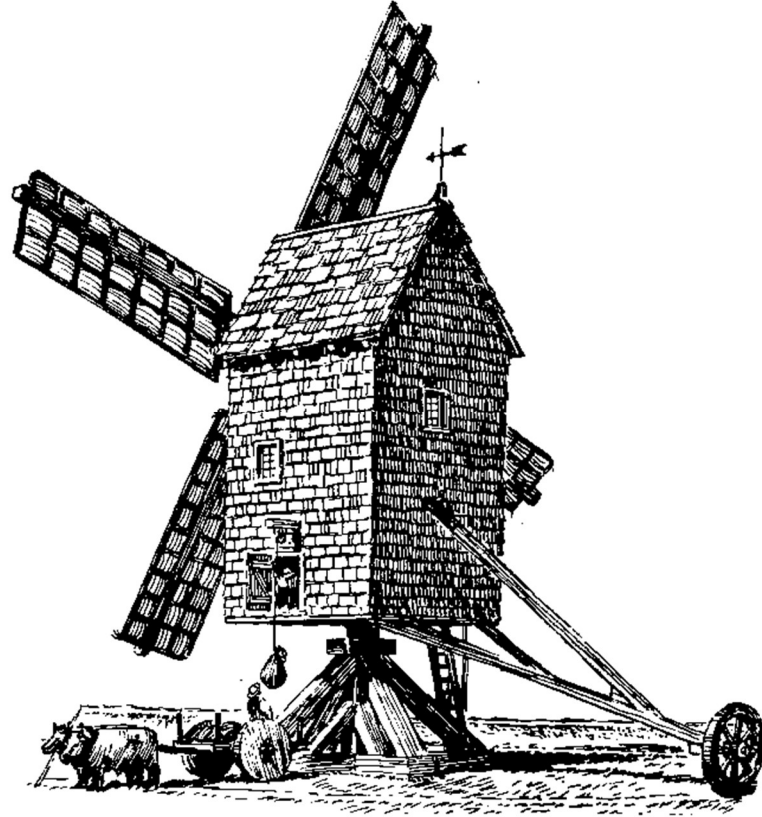

Sketch of a typical post windmill. This amazing little building (also called the buck) rests on a heavy timber framework, with the post that forms the main structural feature of the mill just visible as it enters the bottom of the buck. The stout form was turned into the wind by pushing on the long poles at the back of the mill – in this case fastened to a wheel to make this process slightly easier. The body contained all the milling machinery.

The value of windmills, compared with water mills, gradually gained them even greater popularity: they were cheaper to construct than water mills; and in spite of the vagaries of wind the comparative “portability” of a windmill meant that there were many more siting opportunities.

By the end of the thirteenth century in Europe the tower mill had been introduced, and gradually replaced the post mill. The revolutionary innovation of the tower mill involved the turning apparatus – instead of the whole building rotating, only the cap atop the tower needed to be turned into the wind. This meant that the main structure could be much taller, allowing the sails to be made longer, which in turn enabled them to produce more useful work even in low winds. The spread of tower mills throughout Europe came with growing national economies that called for larger and more stable sources of power. (The tower mill, of which our St. Peter’s example is a type, is discussed in more detail in the next section.)

The tower mill’s cap could be turned either by winches or gearing inside the cap or from a winch on a long tail pole outside the mill, as seen above in the illustration of a post mill. A method of keeping the cap and sails facing into the wind automatically came with the invention in 1745 by Edmund Lee of the fantail, a miniature windmill mounted at right angles to the sails, at the rear of the cap.

The sails that are the key aspect of any windmill—post or tower—typically consisted of a lattice framework on which a canvas sailcloth was spread. The miller could adjust the amount of cloth spread according to the amount of wind available and power needed. In medieval mills, the sailcloth was wound in and out of a ladder type arrangement. Post-medieval mill sails had a lattice framework over which the sailcloth was spread and fastened, while in colder climates the cloth was often replaced by wooden slats, which were easier to handle in freezing conditions.

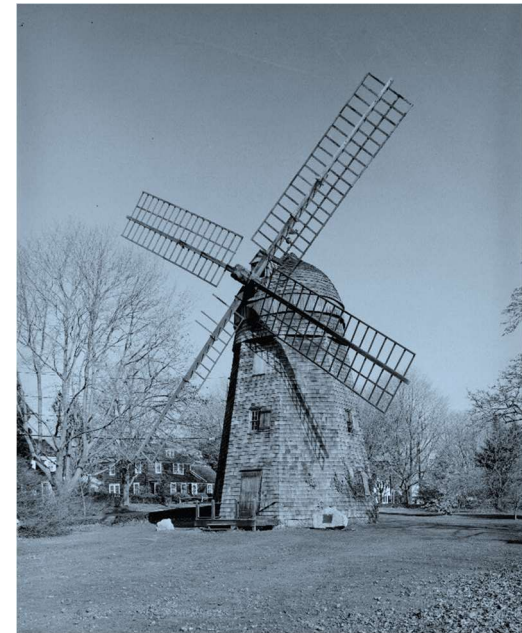

A modest tower mill in England. showing the basic shape, turning cap and sails.

In all cases, the mill needed to be stopped to adjust the sails. Inventions in Great Britain in the late eighteenth and early nineteenth centuries led to sails that automatically adjusted to the wind speed without the need for the miller to intervene, culminating in patent sails invented by William Cubitt in 1813. In these sails, the cloth was replaced by a mechanism of connected shutters.



Lines of windmills in Holland, essential to ensure ongoing drainage of low-lying land for agriculture. Holland boasts the largest number of windmills in Europe – at least 9,000 have been counted over the centuries of their presence in the country.

Clearly, the evolution over the course of several hundred years of the main external elements of the European windmill—from post to tower type, from stretched sail cloth to intricate wooden shutters, from manual to automated operations—is a story of enormous creativity. Within the mill itself, however, the kinds of mechanical apparatus required for specific functions—usually grain grinding or water displacement—relied on a range of intricate wheels and gears that may have become more complex over many years, but were essentially as they had been since the late medieval period.

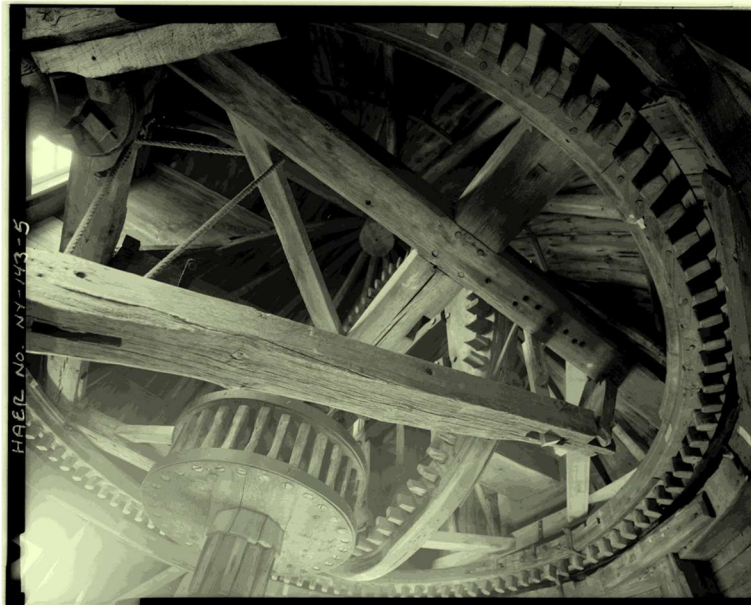

This interior view, of the upper gearings of the Pantigo windmill in New York State, suggests the complexity inherent in the construction and placement of the gearing apparatus required in a windmill. (Image courtesy East Hampton, New York Historic American Buildings Survey)



## Operation of a Tower Windmill

**T**he tower windmill, having been the subject over several centuries of close and keen attention, experiment, revisions and improvements, was by the early 1800s a well known and familiar combination of formal and mechanical elements and features – at least to windmill builders. And while the Red River examples from the 1830s were modest and even rudimentary, they were still of this type, and presumably as sophisticated at least in terms of general mechanics and operations as their thousands of cousins throughout Europe and eastern North America.

This section of the report has been included not only for general interest, to explore the levels of ingeniousness and complexity these Victorian-era manufacturing operations attained, but also to gain an understanding for the imaginative recreation of the 1835 St. Peter’s mill – in its various details and operations.

The following entries have relied greatly on two sources: “Historical Development of the Windmill” by Professor Dennis G. Shepherd of Cornell University (1990, carried out for the National Aeronautics and Space Administration/NASA) and a website devoted to an understanding of tower mill mechanics and operations by English engineer John Hearfield (2007).

It is useful to begin this section with an observation by Professor Shepherd in his NASA article: “Throughout history, windmill technology represented the highest levels of development in those technical fields we now refer to as mechanical engineering, civil engineering and aerodynamics. The best technical minds of their day were constantly seeking to improve the design and operation of windmills. A continuous series of modest changes introduced and tested by builders and millers must have occurred that finally resulted in the refinement and advancement of

windmill technology.” It is within this context that the following information needs to be understood. But before the necessary details of operation are discussed, a general sense of tower mill forms and mechanics is presented.

A large and sophisticated tower mill in cross section (next page) shows some key features and details that will find their way to the much more rudimentary mills of the Red River Settlement in the 1830s and 1840s. At the top of this drawing we see the cap, which holds a large wheel and axle which in turn are joined to the large sails and connecting features shown on the outside left of the cap. It is notable that the axle (known as the windshaft) and thus the sails and large wheel are placed at an angle to the horizontal – it was discovered fairly early on in the evolution of the windmill that this angle (about 15 degrees) was necessary for the efficient functioning of the sails. In this drawing there is a long shaft labelled “brake handle” – this feature was not present on many mills, but is a reminder of the need for a braking mechanism in this section of the windmill that could slow and stop the sails. The brake—usually a smaller wooden element—was more typically adjacent to the large wheel. We can see that this wheel also served another purpose – to turn and thus via its toothed gears drive a smaller wheel directly below the cap. The concatenation of additional axles and smaller gear wheels, shown in the “bin floor” and “stone floor,” were the typical features and arrangements in any mill—wind or water—that was used for grinding grain. The ultimate destination for all of this mechanical activity, and the gradual transition of power, is seen in the “stone floor,” where two “casing[s] with stones” mark the place where grain was deposited and in this case two large grinding stones did their work. In an area here called the “meal floor” one can see two long chutes that emerge below the grinding casings, and where the resulting flour would fall via gravity – there would be bags situated under these chutes when the mill was in operation. In this drawing there are two additional floors below the “meal floor” labelled “grain floor” and “grain store,” where grain waiting for grinding would be housed. The two lower stages, “bedroom floor” and “living rooms” were only

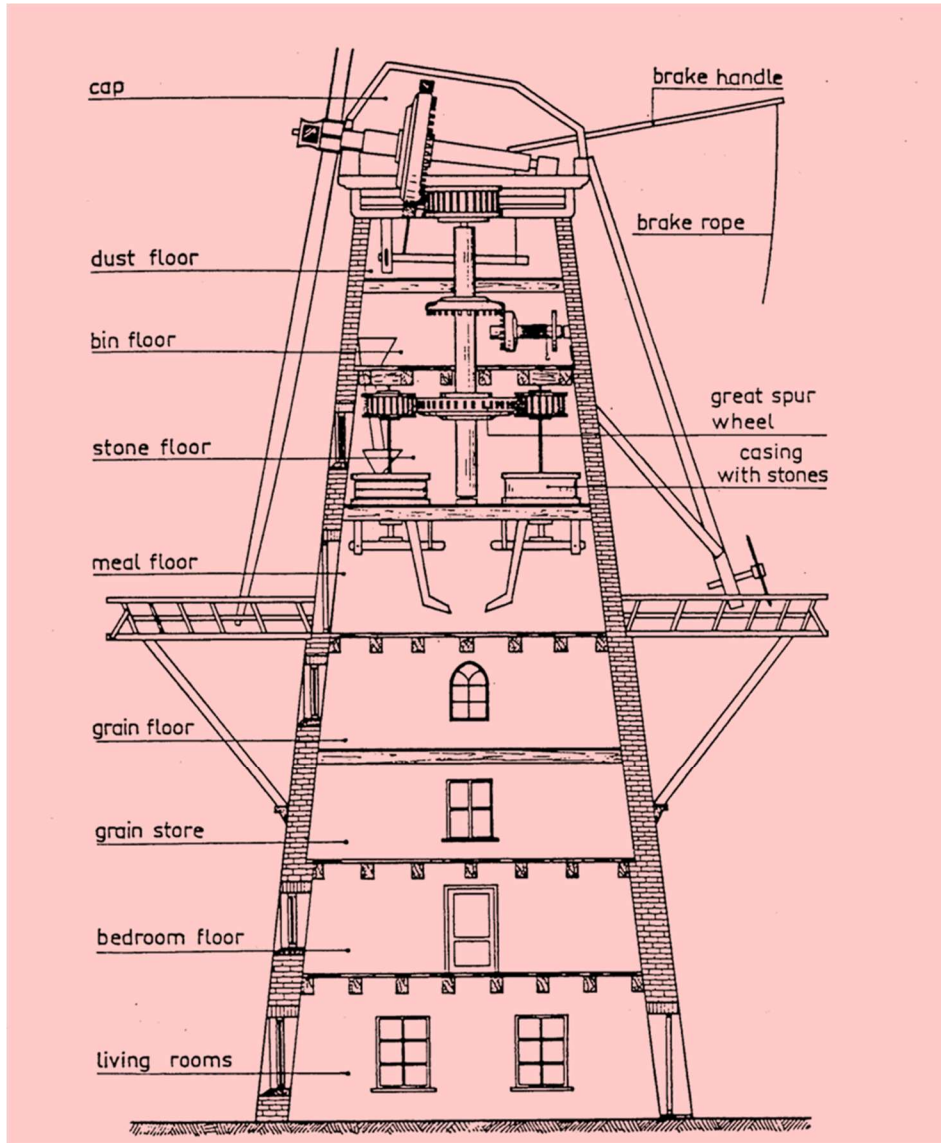

Cross section of a large Dutch tower windmill (Shepherd). This mill, featuring walls of masonry construction, was about 60-65 feet high and about 25-30 feet wide at the base. The St. Peters windmill was 37 feet tall and 21.5 feet at its base. The largest known tower mill was built in East Anglia, England, in 1812 and measured 121 feet (37 metres) high and 40 feet (12 metres) at its base; it was destroyed by a storm in 1905.



developed in the most sophisticated of windmill operations. One final feature shown in this drawing is seen at the “meal floor” stage, where a fenced platform encircles the building – this was very common on tower windmills, the area where a miller could more easily get at the sails, for repairs and adjustments, and in this case at the rope that was attached to the brake handle.

When Professor Shepherd makes the point that “throughout history, windmill technology represented the highest levels of development in those technical fields we now refer to as mechanical engineering, civil engineering and aerodynamics,” he is mostly referring to the specific mechanical features that define a windmill’s operation: the sails, the adjustable cap (in a tower mill) and the power train within the cap. He is generally not referring to the basic formal and structural aspects of a windmill that are actually based on common and straightforward building techniques that attend any historic structure.

At the same time, Professor Shepherd includes in his article some contextual information about form and construction aspects that are specific to windmills, and thus useful for this present exploration of Manitoba windmills:

“Tower mills were often made of brick with a circular cross section or of wood in an octagonal shape. The mills made of timber were covered with clapboarding in England and often painted white, so that they came to be called smock mills, from their supposed likeness to the rural smock or frock [garments]. Many Dutch tower mills had a brick base and a rush-thatched body. There was little difference in the machines and sails of either type [brick or wood], except for those engaged in specialized applications, such as sawmills, which did require some special design considerations.”

“A tower [mill] constructed of bricks could be very sturdy and resistant to weather, but it was not easy to repair if splits appeared as a result of a shift in the foundation or because of the constant vibrations. Thus the usual practice of placing windows in a

linearly symmetrical pattern was sometimes changed to a spiral pattern to avoid lines of structural weakness. Wooden smock towers, on the other hand, were subject to joint opening and subsequent rotting from water seepage. Their multi-sided design included walls with slanted corner posts and beams with beveled ends, all of which required expert craftsmanship and constant maintenance to make them secure and leak-resistant.”

Returning to those technologies so esteemed by Professor Shepherd will see a focus on three essential aspects of a windmill—post or tower type—that are key to its highly particular operation: the power train/windshaft, the cap and the sails. The logical presentation of these features would start with the sails, the initial point of power generation, move to the power train/windshaft and conclude with the cap. However, the following review will instead reorganize this logic based on the complexity of each feature; and thus begin with the simplest, the power train/windshaft, and conclude with the most complex, the sails. A concluding short summary piece will re-present this information in the logical progression.

## The Power Train/Windshaft

In his article, Professor Shepherd provides a labelled diagram, below, to show a windmill's essential power train, from sails (left of the image and not shown in full), through the windshaft and via its various support and component pieces to the wallower and grinding stones below.

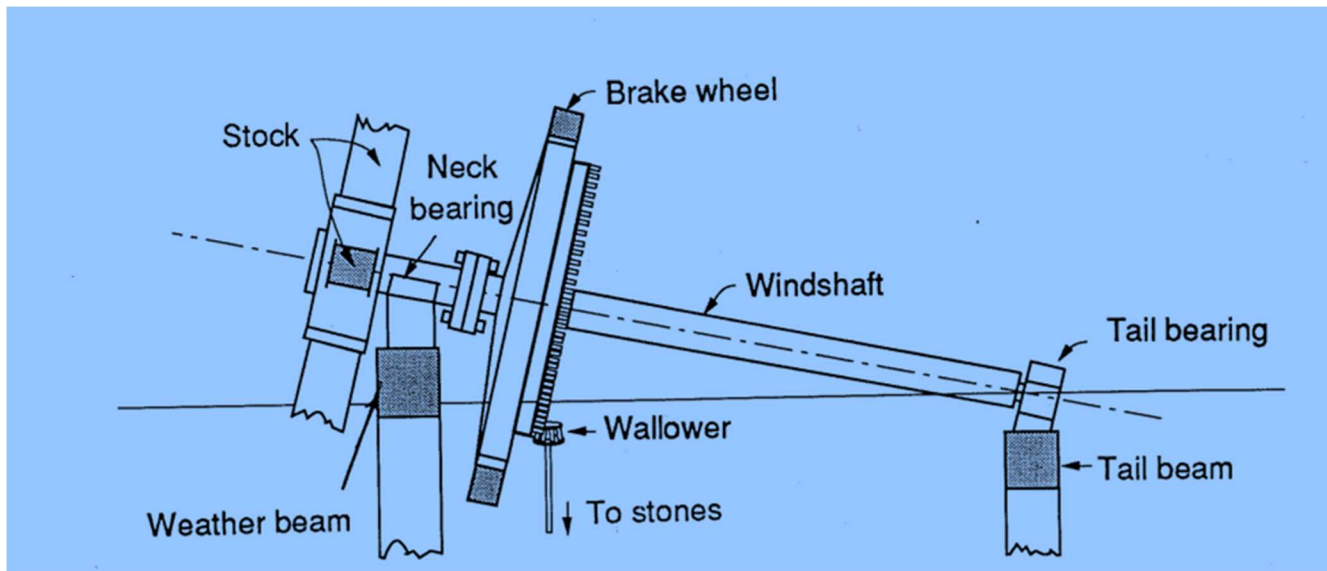

This elevational detail shows the essential power train features that take wind to sail and then into the building via a range of wheels and bearings.

Professor Shepherd provides more detail about this feature's operation: "The sails . . . were carried on the windshaft, which was supported at its forward or breast end by the large breast beam or weather beam and at its rear or tail by the tail beam. The weather beam supported the neck bearing and thus the weight of the sail assembly, which was considerable. The tail bearing took the axial thrust which again was considerable . . ."

“The power take-off from the windshaft was made by a large brake wheel, so called because it also carried the brake on its rim. It was fitted originally with hardwood pegs that transmitted the torque to the wallower, or lantern pinion, the vertical shaft of which either directly or via intermediate gears powered the millstones or other devices below. As time went on, the wooden pegs or staves became shaped cogs. Iron parts replaced some of the wood, and eventually the brake wheel and wallower developed into iron cross-helical gears. The wooden pegs were lubricated and lasted a surprisingly long time; some are in use to this day.”

“The brake was simply a friction band around the circumference of the brake wheel, made of a number of curved wooden blocks banded together, with one end of the band anchored to a timber of the [cap], and the other to a brake lever, itself pivoted at a fixed point on the structure. The active end of the brake lever could be pulled up or down by a rope. The brake lever had an iron pin that could engage with a notch in a catch plate, free to swing from a pin in its head. The brake lever was very heavy, and when it has unsupported by the rope or the catch plate, it pulled the brake blocks sufficiently hard against the rim of the brake wheel to hold the wind shaft at rest.”

“It was advantageous to have the brake be capable of operation at a distance, with the miller on the lower working floor. Application of the brake in a high wind or with full sail, either by design or accident, could start a fire from sparks of metal or ignition of wood because of the heavy friction effect. The miller must have had to keep a sharp eye for sudden storms that might catch him, with sails up, so to speak.”

This cutaway drawing of a post mill, from Denis Diderot and Jean le Rond d'Alembert's 1772 *Encyclopedie*, shows the interior features and arrangements of a post mill – including the large geared wheel at top left that transmitted the rotating power of the sails to other geared mechanisms within.

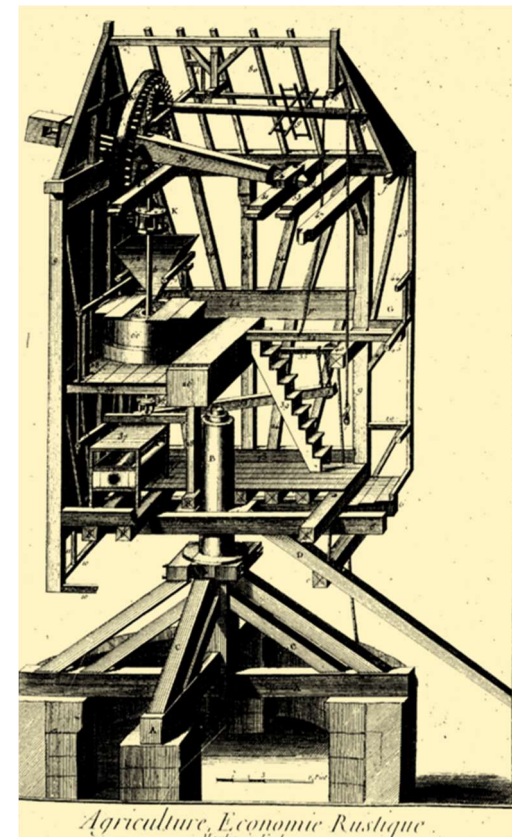

## The Cap

The cap in which the windshaft assembly was situated was a major aspect of a tower windmill's appearance and operation.

As noted by Professor Shepherd: "The cap of tower mills was kept small, and its external design was varied according to the degree that the effect of its shape had on the wind flow behind the sails was recognized, and perhaps according to the aesthetic sense of the miller or builder." This last point will be considered with regards to our Manitoba mills, which have a definite English Tudor architectural character.

Again to Professor Shepherd: "The top of the tower had to be of stout construction and had to have two essential features. The first was the provision of a fixed curb, [track] or rail on which the cap could turn with a minimum of friction between the horizontal surfaces through which the gravity load was transmitted." Turning the cap was absolutely essential to a windmill's operation, ensuring that the sail assembly could be positioned in just the right place to correctly catch and use the force of the wind.

Professor Shepherd adds: "The second feature was a means of keeping the cap truly centred, again with a minimum of friction between vertical fixed and moving surfaces through which thrust loads were carried. The horizontal bearing was initially wood blocks sliding on a curb, well greased, or with iron plates fixed below the cap frame. Later, iron trolley wheels were mounted on a cap ring, and finally iron rollers were placed between special iron tracks attached to both tower curb and cap ring, so that a roller-bearing was effectively formed."

While the fixed curb, track or rail is clearly a major aspect of a tower windmill's design, it is physically a very small feature (compared with other parts) and also rather difficult to illustrate. The examples at right and on the following page aim for a clearer explanation.

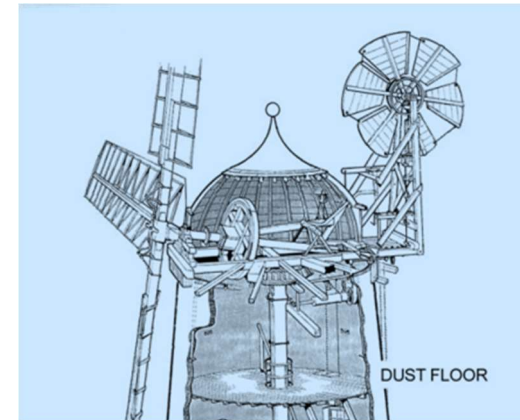

A cutaway drawing of a tower mill showing the interior arrangements of upper sections, including the cap.

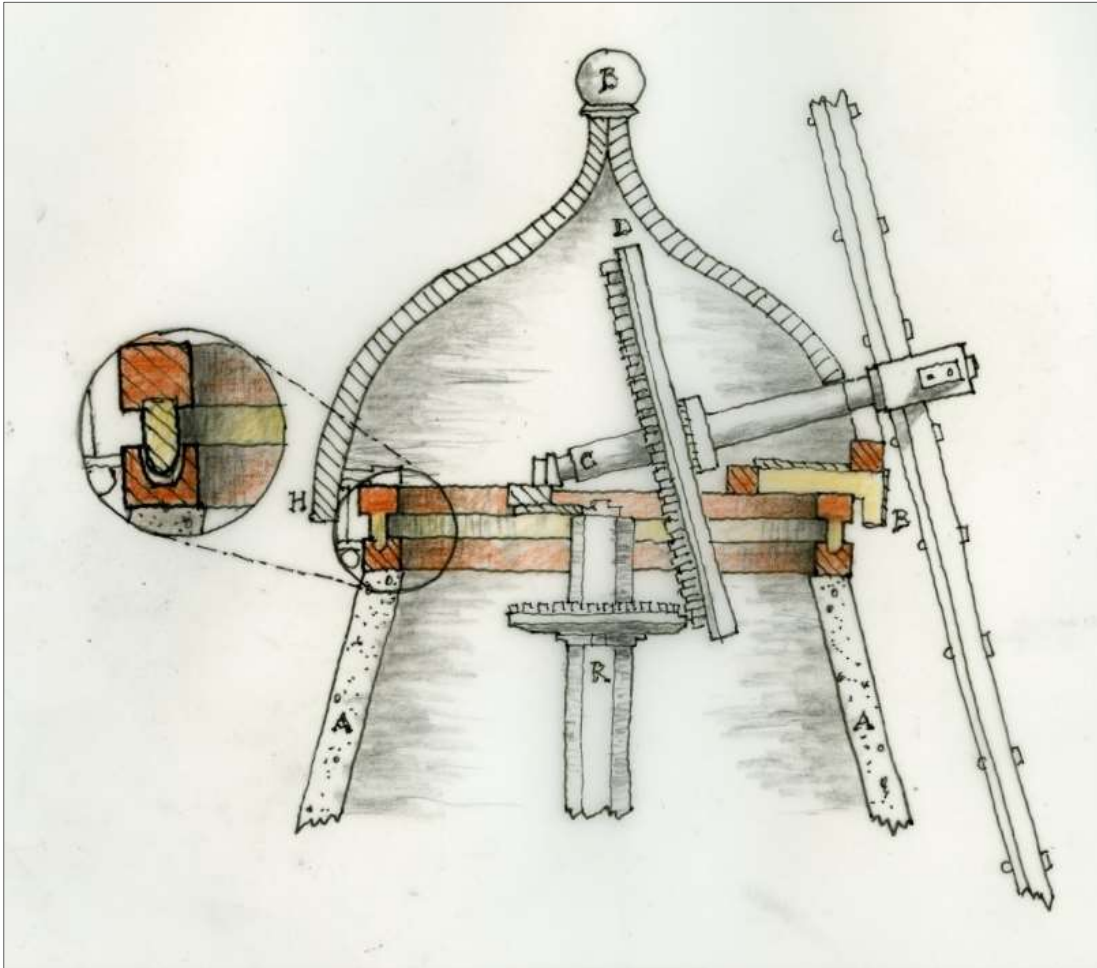

This sectional detail of a tower cap shows via coloured highlighting the key components of the turning apparatus – built up rings (of wood or metal) that allowed the cap to turn. The enlarged section at the far left shows how the upper ring was inset with a narrower ring that fitted into the continuous groove of the curb below it. As was noted by Professor Shepherd, the lower curb and presumably the narrow infill ring would have to be regularly greased for effective operation.

## The Sails

As noted above, a discussion of the sails of a windmill has been presented last, given that these apparently simple and obvious parts of a windmill are actually the most complex and the most difficult to describe – certainly in their actual mechanical and aerodynamic aspects, the qualities that actually made the windmill work so well.

First, some basic history and obvious facts, from Professor Shepherd: “It is likely that the first [windmill] sails [of the fourteenth century] were flat boards, but these were soon replaced by a cloth-covered wooden lattice on a central spar, forming two “ladders” through which the sail cloth was laced over and under alternate transverse battens. These early sails were inclined to the plane of rotation at an angle of about 20 degrees along their whole length.”

“The figure [right] shows the structure of the common sail diagrammatically. The main structural element was the stock, which either was mortised right through the windshaft or was fitted into the iron canister or poll end. It could be as long as 27 metres [nearly 90 feet], although anything longer might have led to structural problems; it was most likely limited to this length by availability of the right kind of lumber. Along the length of the stock were fastened narrower timbers called whips, through which transverse sail bars were mortised at intervals. To the sail bars were nailed longitudinal laths, the outside ones called hemlaths and any intermediate ones called uplongs. In this way, a lattice was formed on which cloth could be attached. The sail bars were initially placed symmetrically on either side of the whip, but in later times the common sail had the stock positioned as shown in the figure.

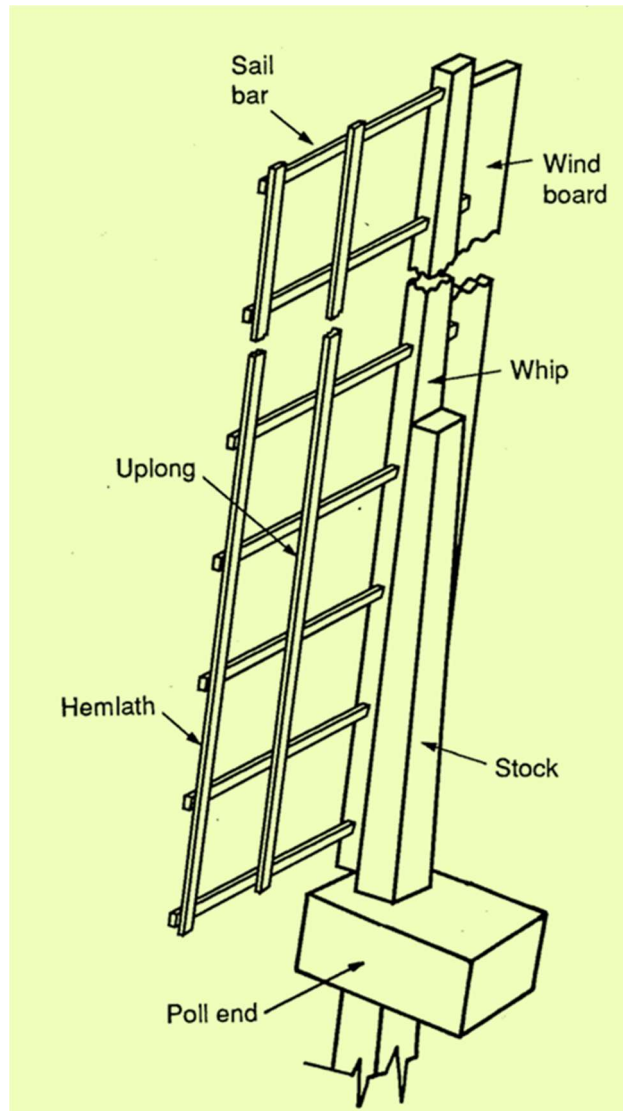

Structural components of the common windmill sail. The stock is a heavy wooden element, likely oak, forming the primary base for the lattice work of uplongs, hemlaths and sail bars that make up the wooden parts of the sail structure.



“The forward end of the sail bars supported a leading edge wind board that directed the wind onto the sail and helped to hold the cloth firmly against the frame. At the poll end there was a transverse iron bar onto which the end of the sail was attached by rings and eyelets in the fashion of a present-day curtain. Ropes were attached along both lengthwise edges of the sail so that it could be drawn radially outwards and fastened at the tip. Note that the tip had to be within reach of the miller, standing on or near the ground, or on the tower stage, for those mills that had one. Furling of the common sail acted to control power and rotor speed. When the mill was not operating, the sail was unfastened at the top, twisted into a roll, and cleated to the whip.”



This reconstructed medieval windmill clearly shows the early sail form and structure described in Professor Shepherd's article and obviously well known even in the 1500s and 1600s: the lattice frame twisted slightly to gain power, the symmetrical positioning of the lattice on the spars, and the sail cloth attached to the lattice.

This useful overview of sail construction, design and operation is probably sufficient for a basic understanding of this key component of a windmill's operation. But Professor Shepherd and Mr. Hearfield both have developed much more technical observations about windmill-sail design, some of which is presented here for those interested in the depth of engineering thought that attended the evolution of these features.

Beginning with Professor Shepherd: "[While the ancient idea of rotating] a right-angle gear mechanism allowed the rotor axis to be transposed from vertical to horizontal, the action of the sails also had to be turned through 90 degrees. This was revolutionary, because it meant that the simple, straightforward push of the wind on the face of the sails was replaced by the action of the wind flowing smoothly around the sail, providing a force normal to the direction of the wind. As a concept, it was indeed a sophisticated one that was not fully developed until the advent of the airplane at the turn of the nineteenth century and the engineering science of aerodynamics."

"In fact, although they were not aware of it, the first builders of the vertical windmill had discovered aerodynamic *lift* and had used it to achieve a greatly improved design over that of *drag*, which is the force that powered the Persian [horizontal] windmills [of the early medieval period]."

"The earliest sails were inclined at a constant angle to the plane of rotation, whereas the common sail was given a twist from root to tip to vary the inclination continuously along its length. This was called weathering the sail, and it was done by mortising the sail bars through the whip at different angles, which might vary from 22.5 degrees at the root to less than zero at the tip. This was undoubtedly an empirical discovery, because it is unlikely that the millwrights were aware of the concepts of *relative velocity* and *angle of attack*. Perhaps weathering was prompted by observations of the behaviour of the stretched cloth along its length "catching the wind" or "filling the sail."

It is now to Mr. Hearfield that we turn for an additional, albeit rigorously complicated, review of windmill sail technologies – essential for an appreciation of the evolution and results of all of this attention and experimentation. He includes in his article some interesting editorial thoughts that are included here for context:

“This article looks at how old wooden windmills and particularly their sails, have come to be the shape they are. It tries to explain how the sails start rotating, why they don’t self-destruct in a gale, and why a windmill sail looks like a piece of garden trellis.”

“There’s something beautiful about a well-designed machine, whether it be a steam locomotive or a fighter aircraft, a clock or a racing car. Every component, large and small, is there for a reason. Each has been made in a particular way, from the most appropriate materials available, to interact with the other components in just the way their designer intended.”

“For me at least, part of the pleasure I get from machines comes from trying to understand how they work. Windmills are not just pleasing to look at. They are machines, and like all machines they have been engineered to do a useful job at minimum cost. Every single component has been thought about, and designed, and optimized.”

Mr. Hearfield then gets to the heart of the matter regarding windmill sails:

“It’s a much more challenging task to extract energy from moving air than from moving water [as in a water mill]. The amount of water flowing through a waterwheel can be controlled quite closely by using artificial millponds and sluices, but the strength and direction of the wind can change dramatically during a day, or even in the course of a few minutes. So the problem faced by an aspiring windmill



View of the sails on a rare five-sailed tower windmill built in the early nineteenth century.

designer is this: how can the energy in an erratically-moving mass of air be harnessed, and then used to drive a shaft at ground level which needs to rotate at more or less constant speed?"

"At first glance, it seems obvious how windmills work. They have huge flat sails that face the wind, so when the sails are rotating they cut through the air just like the wings of an aircraft. But then I asked myself, if the wind is blowing directly at the sails, why should they ever begin to rotate? And whilst an aircraft's wing is a smooth solid surface, a windmill's sails seem to be mostly empty space. The wind would blow straight through the holes."



View of the kind of lattice-work that defined many windmill sail compositions.

“I tried to find out the answers to these questions. My usual sources of information—books, the internet, local library, county library—had practically nothing of any use. This was disappointing, but not really surprising—nobody builds windmills like this anymore, so there’s little point in writing books on how to do it. So I decided to spend a little time thinking about the principles that guided these early millwrights, to see if I could understand why they built windmills in the way they did. The key question seems to be: *How does the wind make the sails revolve?* Once I understood that, it should be easier to see why the sails have the shape they do.”

Mr. Hearfield’s following 10-page dissection and compelling illustrated analysis of windmill sail technology is necessarily dense, complex, and frankly excessive for the present purposes of this project. The following is a summary of the key points of the article.

Mr. Hearfield begins by noting the obvious comparison of a windmill’s sails with those of a sailing ship, looking for similarities of design and function: “Sailing ships capture wind energy and convert it into forward motion, so an obvious starting point in designing a windmill’s sails would be to think about a sailing boat. Boats have been around for a very long time, and to be useful they must have some means of changing the direction of the force supplied by the wind into the direction the captain wishes to steer. With care, they can even sail into the wind.”

“The force of the wind acts on the sail, of course [see diagram right and another on the next page]. That’s what the sail is for. But the sail is attached to the boat, and it’s the boat that moves. If it were a raft, it would move in whatever direction the wind was blowing, but a sailing boat is designed to go in just one direction—forwards.” In the diagram, Mr. Hearfield identifies two forces that act on the sail—one forwards and one sideways. There is considerable analysis following that shows how these forces are captured and controlled, especially in a windmill, with the conclusion that the sideways motion noted here is actually the force that is used for the effective operation of a windmill’s sails.

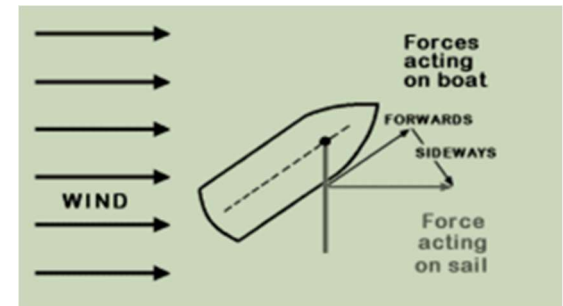

This diagram in Mr Hearfield’s article shows how an angled sail on a ship captures the force of wind to move in a preferred direction. The diagram also shows a key aspect of wind force on the sail—driving the ship both forward and sideways.

Mr. Hearfield then makes this key observation about the force of the wind and the sails, noting that this sideways, or turning, force occurs at right angles to the axis (or centre) of the sail assembly, which is at some distance from the windshaft, and so its effect is to make the mast—and hence the shaft—rotate. He adds: “The size of the turning force evidently depends on the angle between the sail and the wind.”

Through this comparative analysis, Mr. Hearfield appears to have answered his basic question: *How does the wind make the sails revolve?* with the answer that the sails in a windmill must be set at an angle to initiate motion. But he actually wants more clarity – thus not just how the rotation begins, but also: “What should be the [optimal] angle between the sails and the wind?”

He begins this query with this observation: “The logical conclusion of this [that sails need to be set at an angle to the direction of the wind] is that windmills should be built with their sails edge-on to the wind, to use all the available turning force, with the wind flowing over the sails as it does over the wings of an aircraft. In fact, aircraft designers know this turning force as 'lift', and it's what makes aircraft fly. Windmill sails were actually called 'wings' in Anglesey (and 'sweeps' in Kent, and 'arms' in Yorkshire).”

“But if the sails were mounted edge-on to the wind, when they went round they would flail wildly at the air like giant cricket bats, instead of slicing through it smoothly like swords. The resulting turbulence and air resistance would be enormous, and would seriously limit how fast the sails could rotate. This wouldn't do at all, since it was already known that the windmill's power output increases greatly as the speed of rotation rises. On the other hand, if the sails were mounted square-on to the wind, there would be no turning force at all. So it's essential to set the sails at a compromise angle that will persuade them to start moving in slow-moving air, yet still give a reasonable power.”

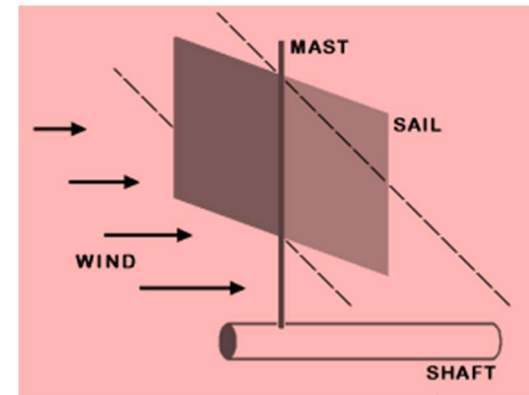

This diagram shows how an angled sail on a ship is set to exploit wind power for movement. A similar action happens with a windmill when its sails are set at a similar angle.

“The optimum angle turned out to be about 15 degrees. As it happened, the first engineer to analyse this properly (in 1759) was one of my heroes – a Yorkshireman called John Smeaton. He pioneered the approach that engineering is an applied science and not just a collection of rules-of-thumb. His achievements included making waterwheels more efficient and building the first Eddystone lighthouse that didn't fall down. Scientists may live in ivory towers, but engineers design them.”

Mr. Hearfield adds some additional information on sail design: “Power output depends not only on the wind speed, but also on the area swept by the sails. Long sails generate more power than short ones, and a typical sail might be 10 metres long and 2 metres wide [about 35 x 6 feet].

“Ideally, the sails should rotate at a constant speed whatever the wind conditions, and in practice this means that additional braking must be applied when the wind speed is high. The most elegant solution would be if the moving sail could itself somehow supply a braking force which increased with speed, and it turns out that this happens if the sail is constructed as an open lattice instead of with a smooth continuous surface. The holes generate turbulence, which act as a brake (and also reduces lift).”

“But whilst increased drag is an advantage when the sails are actually rotating, the reduced lift makes the system more difficult to start. The wind speed has to be higher before the sails can generate enough lift (turning force) to get them moving. So the mill needs solid sails when the wind speed is low, but open lattice sails when the wind is blowing more strongly. How can this dilemma be resolved? The answer is, by using open lattice sails, and covering them with cloth when the wind is light, [as seen in a mill, right] in the middle of the small town of Zierikzee in the Netherlands. It was a cloudy and showery day with hardly any wind when we were there in 2005, but the mill was working. The photograph also illustrates that although the inner edges of the sails (near the hub) do meet the air at about 15 degrees, the angle at the tips of the sails is very much less. This gradual change in angle was another of Smeaton's ideas.”



Zierikzee windmill in the Netherlands, showing the placement of sail cloth that allows the mill to attain ongoing productivity even in low winds.